

# Advanced CCIE Routing & Switching v5.0

[www.MicronicsTraining.com](http://www.MicronicsTraining.com)

**Narbik Kocharians**  
**CCSI, CCIE #12410**  
**R&S, Security, SP**

## Topology

## Switch to Switch connection

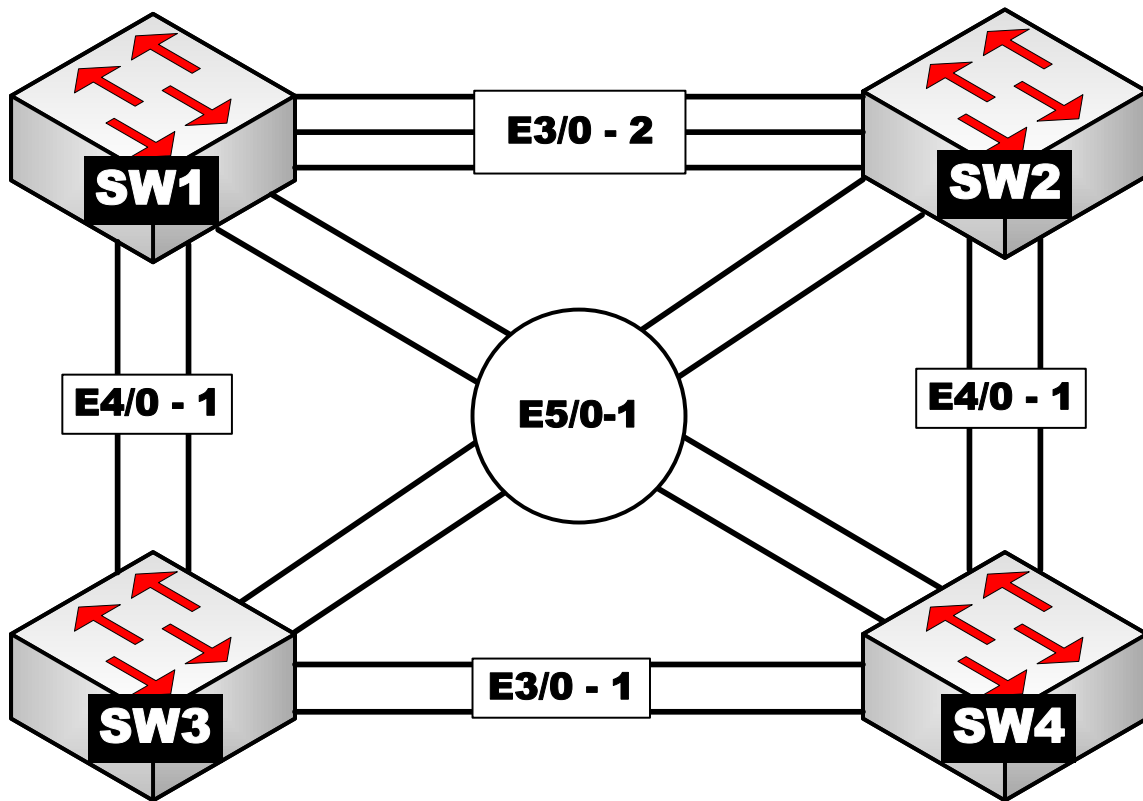

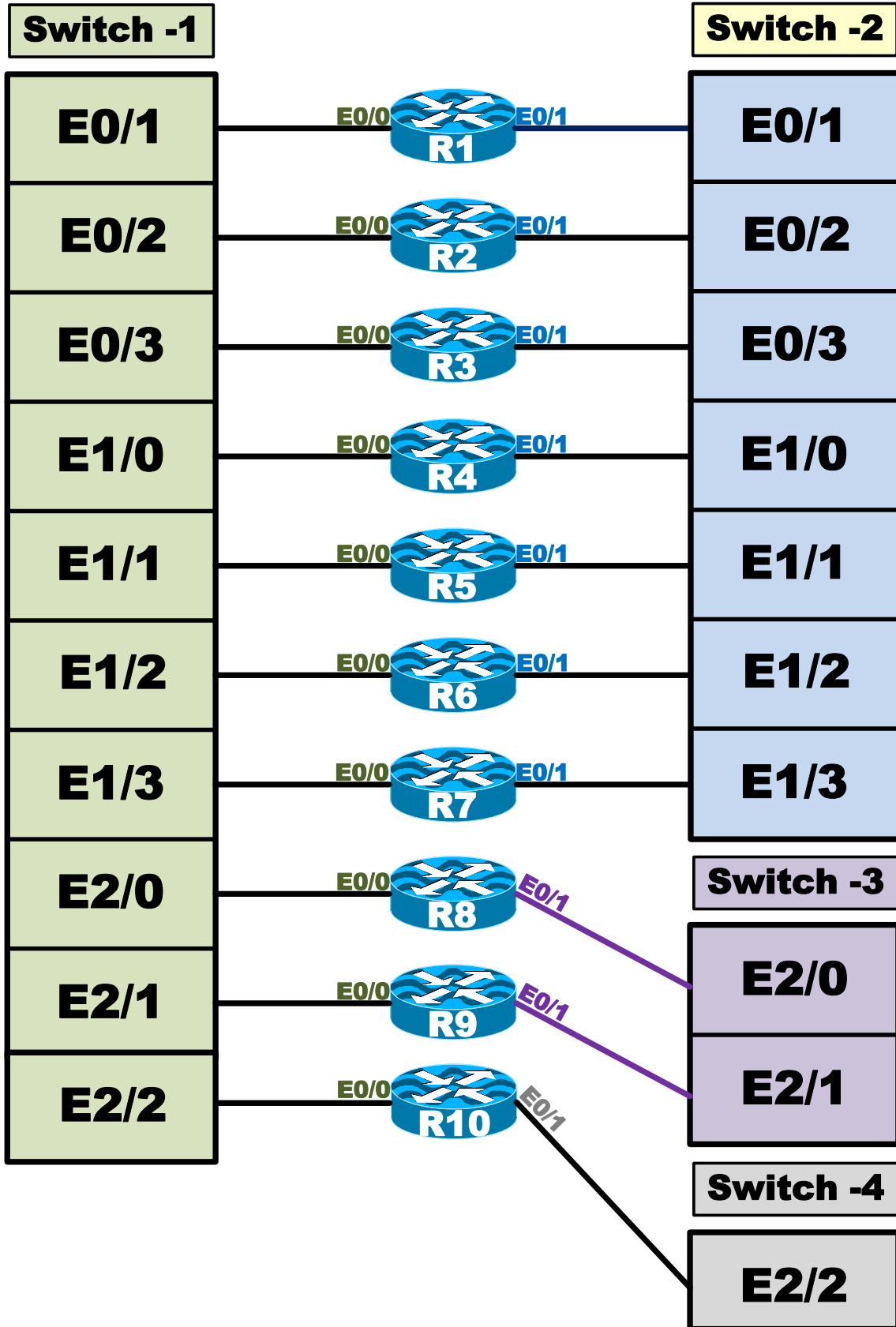

### R1

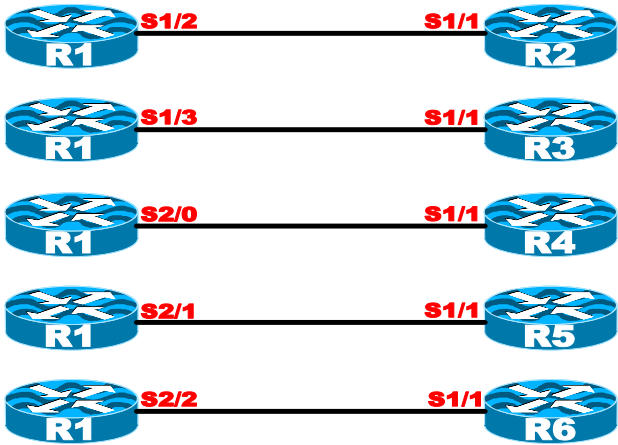

### R2

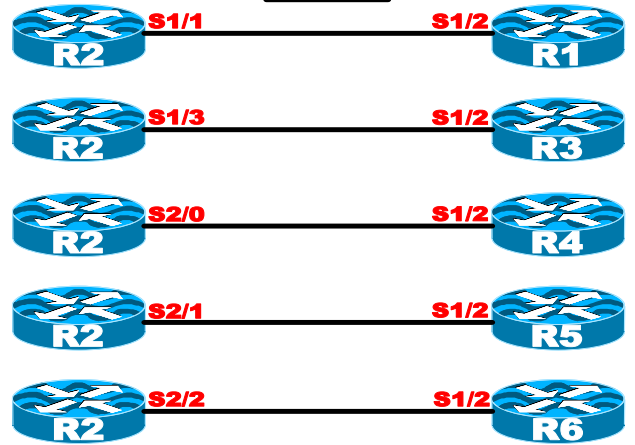

### R3

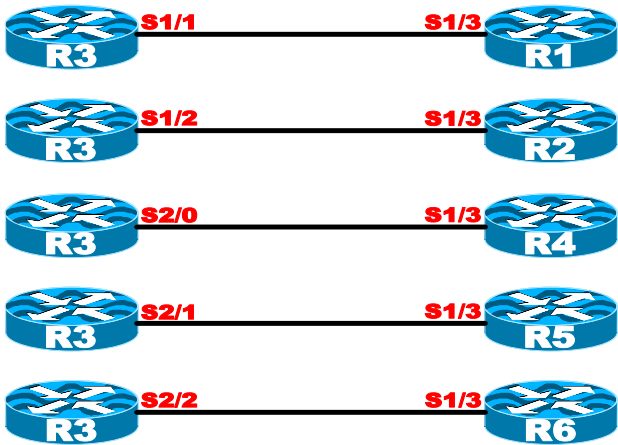

### R4

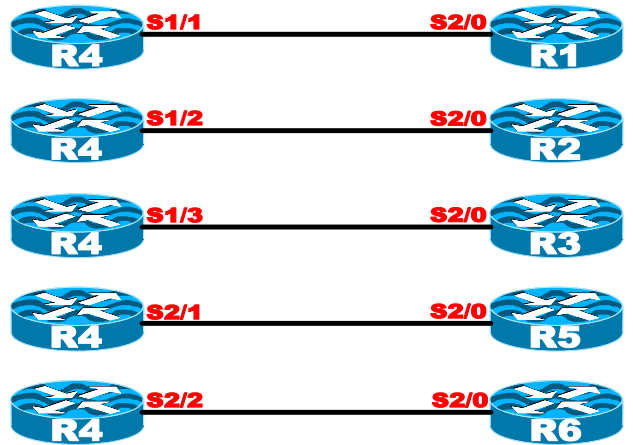

### R5

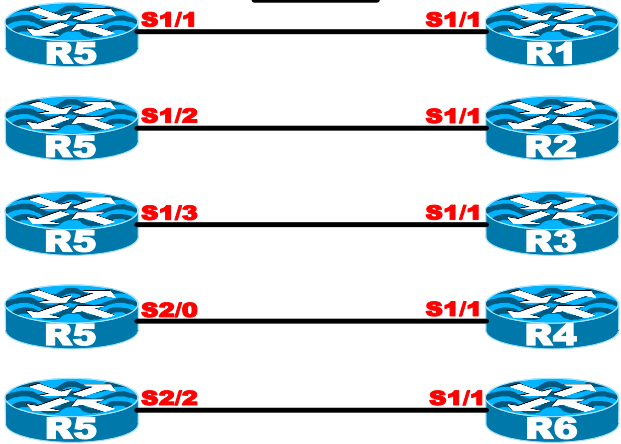

### R6

